

SQC Series

Owner's Manual

This Manual is for the Installation, Operation,
and Maintenance of the

WATER FACTORY SYSTEMS™

SQC3 and SQC4 Series
Reverse Osmosis (RO) Drinking Water Appliance



Installer: Leave with homeowner.

SAFETY INFORMATION

Read, understand and follow all safety information contained in these instructions prior to installation and use of the SQC Series Reverse Osmosis (RO) Drinking Water Appliance. Retain these instructions for future reference.

Intended use:

The Water Factory Systems™ SQC Series Reverse Osmosis (RO) Drinking Water Appliance is intended to connect permanently to a home plumbing system and has not been evaluated for other uses.

EXPLANATION OF SIGNAL WORD CONSEQUENCES	
 WARNING	Indicates a potentially hazardous situation, which, if not avoided, could result in death or serious injury and/or property damage.
CAUTION	Indicates a potentially hazardous situation, which, if not avoided, may result in property damage.
 CAUTION	Indicates a potentially hazardous situation, which, if not avoided, may result in minor or moderate injury and/or property damage.

 WARNING
<p>To reduce the risk associated with choking:</p> <ul style="list-style-type: none"> • Do not allow children under 3 years of age to have access to small parts during the installation of this product.
<p>To reduce the risk of physical injury:</p> <ul style="list-style-type: none"> • All hydro-pneumatic pressurized tanks must have an appropriate pressure relief valve installed. • Shut off inlet water supply and depressurize system as shown in manual prior to filter removal.
<p>To reduce the risk associated with the ingestion of contaminants:</p> <ul style="list-style-type: none"> • Do not use with water that is microbiologically unsafe or of unknown quality without adequate disinfection before or after the system. Systems certified for cyst reduction may be used on disinfected water that may contain filterable cysts. EPA Establishment Number 070595-CT-001. • An approved air gap must exist between the RO System reject drain line and the drain line opening to meet plumbing codes.
<p>To reduce the risk associated with irritation from Sodium Metabisulfite during installation:</p> <ul style="list-style-type: none"> • Sodium Metabisulfite (CAS 07681-57-4) is used in a 1% preservative solution within the reverse osmosis membrane. • Do not put this system into service before the RO tank is flushed as specified in the installation instructions. Wear eye and face protection during installation. • To request an MSDS relating to this product, call 203-238-8965 or visit the web at http://solutions.3m.com/wps/portal/3M/en_US/MSDS (click MSDS search). For emergencies, call 800-364-3577 or 651-737-6501 (24 hours).
<p>To reduce the risk associated with eye, skin and respiratory and digestive tract burns from Calcium Hypochlorite during installation:</p> <ul style="list-style-type: none"> • Calcium Hypochlorite (CAS 7778-54-3) granules are used for tank sanitation in this product. • During installation, do not get in eyes, on skin or clothing. Do not ingest. Wear eye and face protection. Keep out of reach of children. • To request an MSDS relating to this product, call 203-238-8965 or visit the web at http://solutions.3m.com/wps/portal/3M/en_US/MSDS (click MSDS search). For emergencies, call 800-364-3577 or 651-737-6501 (24 hours).
<p>To reduce the risk associated with ingestion of water contaminated with sanitizer:</p> <ul style="list-style-type: none"> • Sanitizer must be flushed from the system before using as directed within the installation instructions.
<p>To reduce the risk associated with hazardous voltage due to an installer drilling through existing electric wiring or water pipes in the area of installation:</p> <ul style="list-style-type: none"> • Do not install near electric wiring or piping which may be in path of a drilling tool when selecting the position to mount the filter bracket.



WARNING

To reduce the risk of eye injury while drilling counter-tops for faucet installation:

- Safety glasses **MUST** be worn during the sink hole drilling operations.

To reduce the risk of injury associated with household bleach:

- **Read and follow** manufacturers directions and cautions
- **Keep out of the reach of children**
- **DO NOT** intermix with other chemicals



CAUTION

To reduce the risk of eye injury while drilling counter-tops for faucet installation:

- Safety glasses **MUST** be worn during the sink hole drilling operations.

CAUTION

To reduce the risk associated with property damage due to water leakage:

- **Read and follow** Use Instructions before installation and use of this system.
- Installation and use **MUST** comply with all state and local plumbing codes.
- **Protect from freezing**, remove filter cartridge when temperatures are expected to drop below 40° F (4.4° C).
- **Do not install** systems in areas where ambient temperatures may go above 110° F (43.3° C).
- **Do not install on hot water supply lines.** The maximum operating water temperature of this filter system is 100°F (37.8°C).
- **Do not install** if water pressure exceeds 100 psi (690 kPa). If your water pressure exceeds 80 psi (552 kPa), you must install a pressure limiting valve. Contact a plumbing professional if you are uncertain how to check your water pressure.
- **Do not install** where water hammer conditions may occur. If water hammer conditions exist you must install a water hammer arrester. Contact a plumbing professional if you are uncertain how to check for this condition.
- Where backflow prevention device is installed on a water system, a device for controlling pressure due to thermal expansion must be installed.
- **Do not** use a torch or other high temperature sources near filter system, cartridges, plastic fittings or plastic plumbing.
- On plastic fittings, never use pipe sealant or pipe dope. Use PTFE thread tape **only**, pipe dope properties may deteriorate plastic.
- Take care when using pliers or pipe wrenches to tighten plastic fittings, as damage may occur if overtightening occurs.
- **Do not** install in direct sunlight or outdoors.
- All hydro-pneumatic tanks must have an appropriate pressure relief valve installed.
- **Do not** install near water pipes which will be in path of a drilling tool when selecting the position to mount the bracket.
- Mount filter in such a position as to prevent it from being struck by other items used in the area of installation.
- Ensure that the location and fasteners will support the weight of the system when installed.
- Ensure all tubing and fittings are secure and free of leaks.
- Do not install unit if collet is missing. Contact Water Factory Systems if collets are missing from any fittings.
- SHUT OFF FUEL OR ELECTRIC POWER SUPPLY TO WATER HEATER after water is shut off.
- The disposable filter cartridge **MUST** be replaced every 12 months, or sooner if a noticeable reduction in flow rate occurs.
- The RO Membrane cartridge **MUST** be replaced at least every 36 months.

IMPORTANT NOTES

- **Failure to install, operate, or maintain your drinking water appliance in accordance with these use instructions or any other installation or use instructions accompanying this product may result in product failure and property damage, including water leakage and will void warranty.**

INTRODUCTION

This manual explains the installation, operation and maintenance of the Water Factory Systems™ SQC Series Reverse Osmosis (RO) Drinking Water Appliances. Please read each section of this manual carefully. The specific model chosen should be appropriate for the local water conditions and the customer's needs. Check the Performance Data Sheet for the performance characteristics and the conditions of use.

The Water Factory Systems undercounter RO drinking water appliances are designed to connect permanently to a home plumbing system. To ensure that the installation conforms to your state and local plumbing codes, it is recommended that the installation be performed by a qualified installation specialist for RO drinking water appliances or a licensed plumber. Failure to install the system as instructed will **VOID** the warranty.

TABLE OF CONTENTS

I. Installation Instructions

A.	Determine the appliance location.....	3
B.	Prepare the area for installation.....	3
C.	Prepare the appliance for installation.....	4
D.	Make the faucet mounting hole.....	4
E.	Mount the faucet.....	5
F.	Install Stem Adapter With 1/4" Feedwater Tube Outlet.....	6
G.	Prefill and sanitize the storage tank.....	6
H.	Install the drain connection.....	7
I.	Install the filtration assembly and storage tank.....	7
J.	Make the tubing connections.....	8
K.	Install the icemaker hookup (optional).....	8
L.	Start up the appliance.....	8
M.	Flush the appliance of the preservative and check the operation.....	9
N.	Cleanup & paperwork.....	9
O.	Appendix for basement installations.....	11
P.	Installation troubleshooting.....	12

II. Operation & Maintenance Instructions

A.	Important water quality assurance requirements.....	13
B.	Replacing the filter cartridges.....	13
C.	Replacing the RO membrane cartridge.....	13
D.	Sanitizing the RO appliance.....	14
E.	Long term non-use.....	15

I. Installation Instructions

A. DETERMINE THE APPLIANCE LOCATIONS

The appliance can be located under a sink or in a basement depending on space availability and the customer's preference. If a basement installation is selected, additional tubing, hardware and fittings may be needed and a hole will have to be made from inside the cabinet, through the floor, to the basement. **Never** install it in an area of the home where the temperature may drop below 40°C, because damage to the appliance may occur.

The exact placement of the various components of the appliance will vary from installation to installation. The installer, in conjunction with the customer, must decide on where to place the faucet, tank and filtration assembly by balancing the homeowner's convenience with ease of installation and servicing. (See Fig. 1 & 7)

Considerations for an icemaker or other remote hookup should be predetermined, including routing and any additional tools, fittings, and tubing that may be required.

B. PREPARE THE AREA FOR INSTALLATION

Remove supplies from under the sink and stack them neatly away from the working area. Arrange a light for the work area, if necessary.

If a basement installation is called for, determine where the components will be located and how they will be mounted. Special mounting brackets and hardware may be necessary to secure the appliance to a wall or ceiling joists. (See Figure 7)

Inspect the cold water supply line and determine if any special fittings, in addition to what is included in the kit, are required.

NOTE: It is a good idea at this time to check the condition of the undercounter plumbing for any existing or potential leaks. Make sure to perform any necessary repairs prior to the installation of the drinking water device.

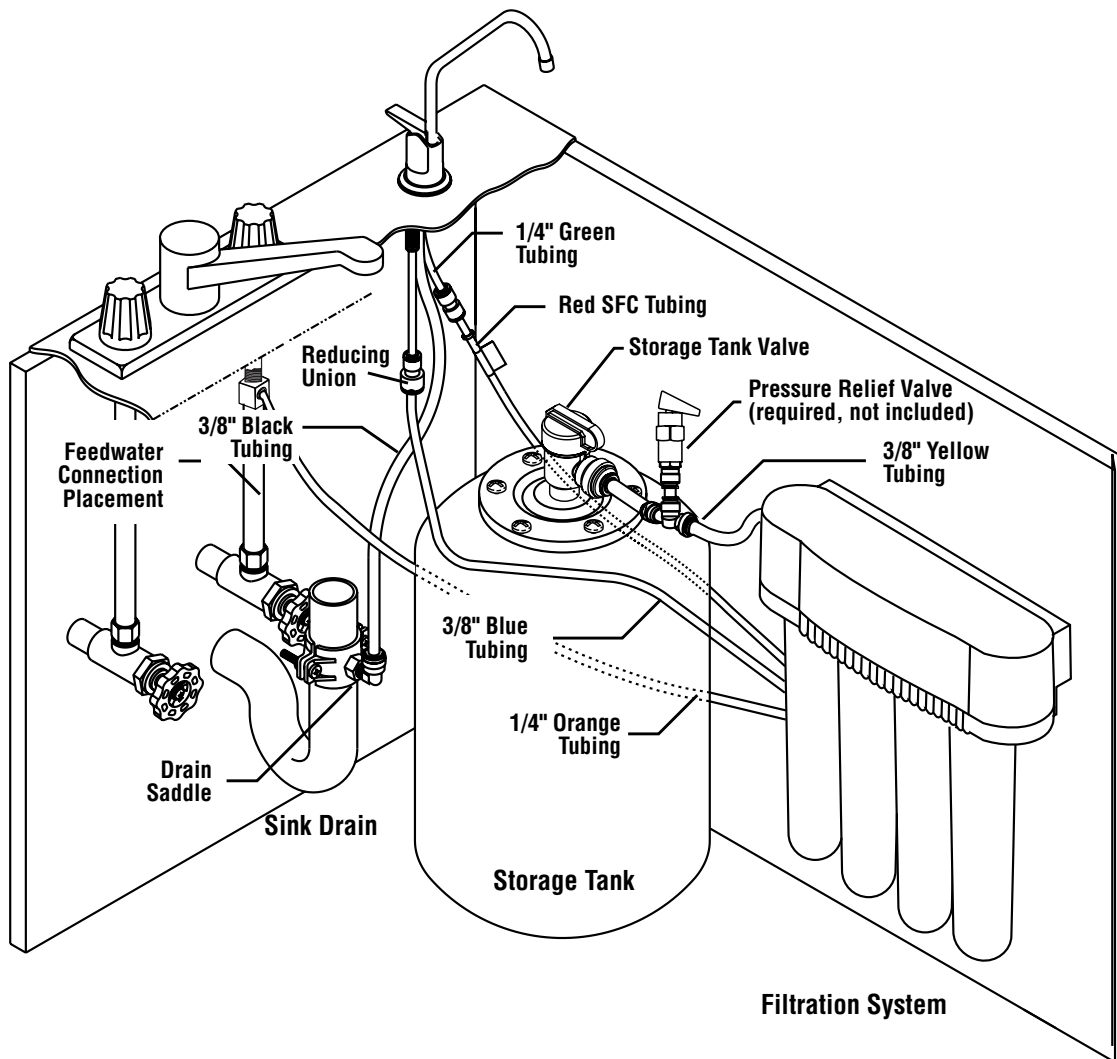

Fig. 1

C. PREPARE THE APPLIANCE FOR INSTALLATION

Open the shipping carton and remove the components. Check to see that all of the installation parts are present. They should include the filtration assembly, storage tank, faucet, installation hardware, RO membrane, cartridges and tubing. Check to see that the air supply in the empty tank is approximately 7 psi (48 kPa). Adjust it if necessary. To reduce the risk of cartridge contamination, the RO membrane cartridge has been shipped separately in a sealed plastic bag. Follow the steps below to install the RO membrane cartridge.

STEP 1: Cut open the sealed plastic bag and remove the RO membrane cartridge.

STEP 2: Remove the white plug from the fitting at the bottom of the cartridge by pushing in the small gray collet and pulling out the plug simultaneously (see Figure 6).

STEP 3: Connect the red SFC reject tubing by inserting the open end into the fitting at the bottom of the RO membrane cartridge as far as it will go. Take note of the tag attached to the SFC tube which indicates the outlet end.

STEP 4: Remove the red plastic cap from the top of the cartridge.

STEP 5: Line up the cartridge ears (Fig. 8), insert the cartridge and push it into the head until it is fully seated. Twist the cartridge 1/4 turn counterclockwise to lock it into place. The final orientation should be such that the cartridge label faces towards the front and the fitting is located towards the rear.

D. MAKE THE FAUCET MOUNTING HOLE

A wide variety of RO faucet mounting situations may be encountered. The most common are stainless steel or ceramic on metal sinks. Consult your dealer for any other materials which may be encountered. The faucet should be positioned so that it empties into the sink and the spout swivels freely for convenience. If the sink already has a hole provided that can accommodate the RO faucet, then no drilling is required.

 WARNING
To reduce the risk of eye injury while drilling counter-tops for faucet installation:
<ul style="list-style-type: none">• Safety glasses MUST be worn during the sink hole drilling operations.

IMPORTANT NOTE
<ul style="list-style-type: none">• If desired, sprayers can be disconnected to provide a suitable mounting hole for the RO faucet. A pipe cap or plug will be required to seal the sprayer connection.

Before drilling the hole, always check underneath the sink to ensure that nothing will interfere with mounting the faucet such as reinforcing ribs, support brackets or the cabinet construction.

Stainless steel sink, air gap or non-air gap faucet.

Recommended tools:

- Center punch
- Variable speed drill and high speed drill bits
- Greenlee 7/8" chassis punch (alternate 9/16" may be used for a non-air gap faucet)
- Protective gloves

Procedure:

- 1) Center punch a small indent at the center of the desired faucet location.
- 2) Slowly drill the required pilot hole for the chassis punch.
- 3) Set up the chassis punch per the instructions and tighten the nut to cut the desired hole size.
- 4) Clean up all sharp edges with a file if necessary.

Porcelain/Enamel/Ceramic sink on sheet metal or cast iron base; air gap or non air gap faucet.

Recommended tools:

- Variable speed drill
- Relton 7/8" porcelain cutter tool set (alternate 9/16" porcelain bit may be used for a non-air gap faucet)
- Plumber's putty

It is important to understand what is involved in this procedure. First, the glassy layer of porcelain must be penetrated through to the base metal. Second, a center disc of porcelain must be removed while protecting the surrounding porcelain against chipping or fracturing. Third, the base metal must be drilled through to complete the hole.

Procedure:

- 1) Mark the center for the 7/8" hole.
- 2) Form a shallow putty dam around the hole area and fill it with enough water to lubricate the carbide drill bit.
- 3) Carefully drill a pilot hole through the porcelain/enamel and the base metal using a carbide type pilot drill.
Important: Always operate the drill with light bit pressure at a slow speed (300-400 rpm).
- 4) Insert the pilot tip of the spring-loaded porcelain cutter into the pilot hole.
- 5) Drill the porcelain/enamel using the spring-loaded porcelain cutter, making certain a complete ring has been cut through the porcelain/enamel to the metal base.
- 6) Change to the metal cutter. With a slow speed and light pressure, cut away the inner porcelain/enamel disc down to the base metal. Make certain that the cutter does not touch the outer rim of the cut porcelain/enamel. Continue with this bit to cut completely through the metal.

IMPORTANT NOTE
<ul style="list-style-type: none">• When using a porcelain cutter it is critical that it is always in a sharpened condition. Dull cutters are known to chip sinks.

Drilling 7/8" diameter hole through countertop or stainless steel sink:

1. Locate area to be drilled. Mark center of hole with center punch.
2. Drill hole with 7/8" drill bit suitable for countertop materials or cast iron/stainless steel.
3. With grinding wheel or file, smooth out any rough edges.

E. MOUNT THE FAUCET

Undercounter installations generally require that the faucet's built-in air gap be used. In basement installations, the built-in air gap does not have to be used if one is provided elsewhere on the drain line.

**For Basement Installations Without An Air Gap Module
See Installation Instructions on page 11.**

IMPORTANT NOTE

- The Uniform Plumbing Code dictates that there must be an air gap between the RO reject line and the waste drain. An optional non-air gap faucet, which requires a smaller 9/16" mounting hole, is available to make basement installations easier.

Undercounter Installation With An Air Gap Faucet:

- 1) Familiarize yourself with all of the components shown in the air gap faucet diagram. (See Fig. 2)
- 2) Remove 3/8" tubing in front of the black faucet handle and discard. Push faucet spout into where the 3/8" tubing was just removed.

- 3) Slide the chrome base plate and rubber washer up the threaded base of faucet.
- 4) Connect the 1/4" green tubing supplied in the installation kit to the smaller barb on the air gap faucet. Push it on firmly until it seats.
- 5) From above the sink counter-top, feed the air gap tubing and the threaded nipple through the faucet mounting hole and position the faucet spout over the sink.
- 6) From below the sink/countertop, install the white spacer (open side toward the air gap tubing), flat washer, lock washer and hex nut onto the threaded nipple and tighten it by hand.
- 7) Back off on the hex nut just enough to slide the slotted washer (open side toward the air gap tubes) between the white spacer and the underside of the sink/countertop.
- 8) After rechecking the faucet orientation, tighten the hex nut with a 9/16" wrench until the faucet feels secure.
- 9) From above the sink, make any minor orientation corrections by turning the faucet on its flats with a padded adjustable wrench. Use care so as not to mar the chrome finish.

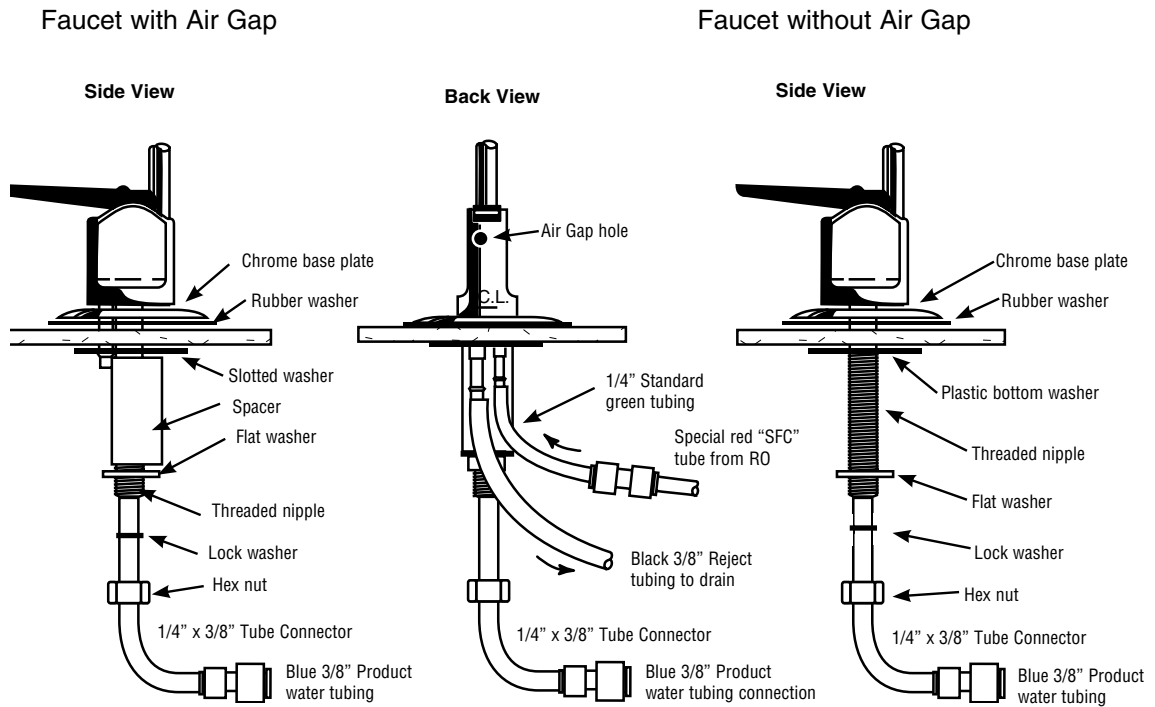

Fig. 2

F. INSTALL STEM ADAPTER WITH 1/4" FEEDWATER TUBE OUTLET

IMPORTANT NOTES

- For basement installations, the existing orange feed water tubing may have to be longer to reach the faucet adapter.

- 1) Open faucet and turn off cold water supply to relieve pressure.
- 2) Locate the cold water stem on the underside of the faucet fixture. Unscrew the cold water feed tube from the faucet stem. Locate the Faucet Adapter that came with your drinking water system. Insert the black gasket into the threaded adapter and tighten onto the Faucet Cold Water Stem under the sink, making sure that 1/4" side connection is accessible and not facing the wall. Make sure not to overtighten.
- 3) Take the Cold Water Feed Tube and attach to the Faucet Adapter, making sure not to over tighten.
- 4) Locate the 1/4" Orange Tubing and insert into the 1/4" outlet of Faucet Adapter. See Figure 3 and "Using Push-in Fittings" below.
- 5) Leave cold water supply off.

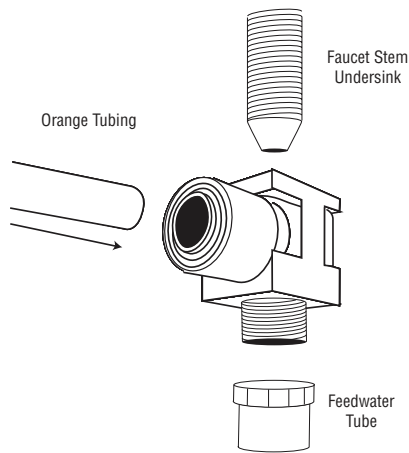
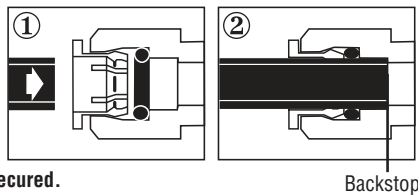

Fig. 3

"Using Push-In Fittings"

To Attach Tubing

Push tubing in as far as it will go. Tubing must be inserted past o-ring and hit backstop. Pull tube to ensure it is secured.



To Release Tubing

Push in grey collet to release tubing. With collet held, pull tubing straight out.

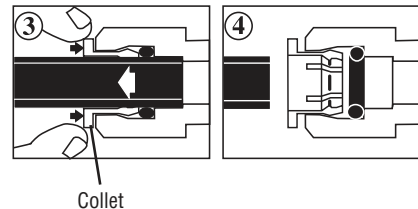

CAUTION

- To reduce the risk associated with property damage due to water leakage:
- Ensure all tubing and fittings are secure and free of leaks.

G. INSTALLATION SANITIZING*
PREFILL AND SANITIZE THE STORAGE TANK

WARNING

To reduce the risk associated with eye, skin and respiratory and digestive tract burns from Calcium Hypochlorite during installation:

- Calcium Hypochlorite (CAS 7778-54-3) granules are used for tank sanitation in this product.
- During installation, do not get in eyes, on skin or clothing. Do not ingest. Wear eye and face protection. Keep out of reach of children.
- To request an MSDS relating to this product, call 203-238-8965 or visit the web at http://solutions.3m.com/wps/portal/3M/en_US/MSDS (click MSDS search). For emergencies, call 800-364-3577 or 651-737-6501 (24 hours).

To reduce the risk associated with ingestion of water contaminated with sanitizer:

- Sanitizer must be flushed from the system before using as directed within the installation instructions.

Prefilling the storage tank is always recommended so that there is pressure to check for leaks as well as sufficient water to flush the carbon postfilter. The SQC RO Drinking Water Appliance is furnished with a container of special sanitizing granules. It is important to use a sanitizer when prefilling the tank.

- 1) Remove protective cover from storage tank and discard. Locate the enclosed container of sanitizing granules, open it and pour the contents into the end of the tank. Apply PTFE tape (not included) to threaded tank connection and install tank valve onto connection. Do not over tighten. Open the tank valve so that the tank valve handle is parallel to the valve body.
- 2) Disconnect the 3/8" yellow tubing from the back of the filtration assembly and connect one end of it into the tube fitting located on the tank valve.
- 3) Connect the other end of the 3/8" yellow tubing to the 3/8" x 1/4" union connector included in the tank sanitization kit.
- 4) Connect the free end of the 1/4" orange feed water tubing to the other end of the 3/8" x 1/4" union connector.
- 5) Open the cold water supply shut off valve (making sure the tank valve is still open) and allow the tank to fill (about 3 minutes).
- 6) Close the cold water supply shut off valve and the tank valve. Disconnect the 3/8" yellow tubing from the tank valve elbow fitting and set the tank aside while proceeding with the rest of the installation (the sanitizing solution should be kept in the tank for at least 15 minutes).
- 7) Reconnect the 3/8" yellow tubing to the back of the filtration assembly. Reconnect the 1/4" orange tubing to the feed water fitting on the filtration assembly.

IMPORTANT NOTES

- If you encounter difficulty in removing the tubing from the tank, make sure the tank valve is closed and then cut the yellow tubing approximately 1" away from the tank valve fitting to relieve the pressure. Remove the 1" piece from the tank fitting.
- If an alternate storage tank is used, it should be sanitized with household bleach (5-1/4%). Use 3 ml. (1/2 teaspoon) of bleach for a 2.5 gallon tank.
- After the installation is complete, it is recommended that the 3/8" x 1/4" union connector be saved for future use in tank sanitization.

* For Yearly Owner Maintenance Sanitizing Instructions, see page 14

H. INSTALL THE DRAIN CONNECTION

IMPORTANT NOTES

- Before starting this procedure, inspect the condition of the drain piping, especially in older homes where the traps and tailpieces can be deceptively thin and frail. If they are in poor condition, it is wise to inform the customer that the condition should be remedied.
- Some local plumbing codes may prohibit the use of saddle-type valves and/or drain connections. The use of saddle-type valves are prohibited in Alaska, Delaware, Idaho, Kentucky, Massachusetts, Michigan, Minnesota, New Hampshire, North Dakota, Ohio, and South Dakota. Check your local plumbing codes for any restrictions that apply. Massachusetts CMR 248 strictly prohibits the use of saddle-type valves. The feed water connection must conform to applicable plumbing codes.

Undercounter Installation:

The drain saddle assembly is designed to fit around a standard 1-1/2" OD drain pipe. For smaller (lavatory type) or larger (ABS pipe) drains, consult your dealer for special drain saddles.

The drain saddle should always be installed above (before) the trap and on the vertical or horizontal tailpiece. Never install the drain saddle close to the outlet of a garbage disposal because plugging of the RO drain line may occur. (See Fig. 4)

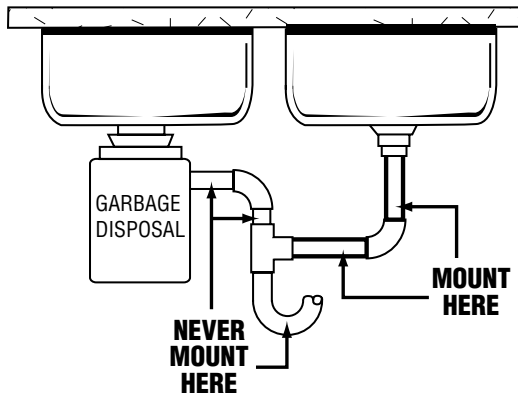

Fig. 4

- 1) Remove backing on foam seal and place over hole on threaded half of the drain saddle. Place drain saddle at the selected location and mark the pipe through the threaded opening.
- 2) Drill a 1/4" hole at the marked location through one side of the drain tailpiece.
- 3) Position both halves of the drain saddle on the drain pipe so that the threaded opening is lined up with the hole in the drain pipe.
- 4) Use the screws and nuts to clamp the drain saddle onto the drain pipe. Make sure that there is equal space between saddle halves on each side. Do not overtighten. (See Fig. 5)
- 5) Orient the elbow in the direction of the RO faucet location.

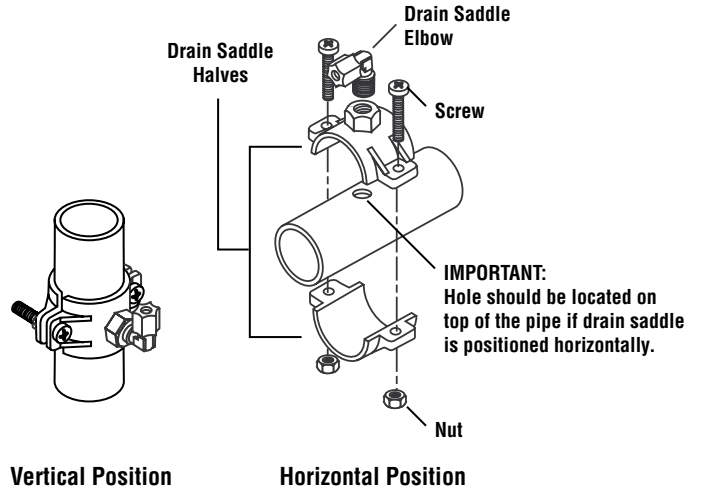

Fig. 5

I. INSTALL THE FILTRATION ASSEMBLY AND STORAGE TANK

For Basement Installation See Installation Instructions O.

Undercounter Installation:

The filtration assembly is usually mounted to the right or the left side wall inside of the sink cabinet, taking into consideration the space available and the tank location. Generally, the storage tank is placed in the rear of the sink cabinet while the filtration assembly is positioned toward the front for filter cartridge accessibility.

To mount the filtration assembly, elevate it at least 2" (5 cm) off of the cabinet floor and, while keeping it level, mark the location of the mounting holes on the cabinet side wall. Make small pilot holes with an awl or a drill and screw in the two mounting screws; leaving just enough protruding to allow the bracket mounting slots to slide over them.

IMPORTANT NOTE

- If the cabinet side walls are not of solid construction, the filtration assembly can be set on the cabinet floor and held against the side wall with the mounting screws. However, the filtration assembly will then need to be lifted from the mounting screws in order to remove the filter cartridges.
- It is essential that the filters be installed in the correct location. Use the icon coded label to match the replacement filters with their corresponding filter heads.

The storage tank may be oriented either vertically or horizontally. It is generally placed to the rear of the cabinet but can be set in the front center (between the sink basins) for ease of access if space permits. For horizontal positioning, carefully detach the tank base from the tank bottom and use it as a cradle.

J. MAKE THE TUBING CONNECTIONS

With all of the components in place, the tubing connections can be made. When routing the tubing between the components, several guidelines should be observed.

- Tubing runs should generally follow the contour of the cabinet rather than interfere with the cabinet storage area.
- Strive for a neat and orderly tubing “flow” by using fasteners (e.g. insulated staples) to secure the tubing.
- Arrange the tubing so that there are no sharp bends. Leave some “play” in the tubing for ease of servicing, then cut the tubing to the desired length.
- Try to keep the tubing from the filtration assembly to the tank and faucet as short as practical for good flow.

For Basement Installation See Installation Instructions O.

Undercounter Installation:

The appliance will have the 3/8” yellow and the 3/8” blue tubing already connected to the filtration assembly.

- 1) The 1/4” orange tubing should already have been connected to the cold water supply shut off valve. Route the other end through the large opening in the “bottom of the metal bracket and loop it back to the “Feed” connection on the filtration assembly.
- 2) Attach the 1/4” x 3/8” union to 1/4” blue tubing on faucet.
- 3) Connect the 3/8” blue tubing from the filtration assembly to the other end of 3/8” x 1/4” union.
- 4) Route the 3/8” black tubing from the faucet air gap to the drain saddle so that it slopes continuously downward without any loops or low spots. Cut the tubing to the proper length and connect it to the drain saddle elbow.
- 5) Connect the 3/8” yellow tubing from the filtration assembly to the tank.
- 6) Remove the plug from the elbow fitting on the RO module cartridge. Insert the special SFC tube into this elbow fitting. (Note: The elbow fitting is labeled “drain” on the RO module.) Route the special red SFC tubing toward the faucet. **Do not cut this special SFC tubing.** Its length is important to maintain proper efficiency and performance.
- 7) Cut the 1/4” green tubing from the faucet air gap to the proper length and connect it to the 1/4” connector fitting on the end of the SFC tubing.

K. INSTALL THE ICEMAKER HOOKUP (optional)

The RO drinking water appliance can be connected to any standard refrigerator icemaker or icemaker/water dispenser. It should never be connected to a commercial type bar icemaker.

Hooking up an icemaker involves connecting a tee with a shut off valve into the 3/8” blue faucet tubing and routing the tubing over to the refrigerator. Hooking up to existing copper unit is generally not recommended unless it is less than six months old. If copper tubing must be used, then the installation of a small in-line carbon filter at the refrigerator connection is recommended.

Before turning off the existing tap water supply to the refrigerator icemaker, always shut off the icemaker first (usually by lifting the lever arm above the bin to the uppermost position). The icemaker should only be turned on again **after** the RO system has been drained several times and the storage tank has a **full** supply of water.

IMPORTANT NOTES

- Before any service is performed on the RO appliance, always turn off the icemaker valve and the icemaker unit. Only turn them on when the system is operating and the tank is full.

L. START UP THE APPLIANCE

- 1) Double check to see that all of the connections are secure.
- 2) Open the cold water supply shut off valve and check the appliance for leaks. If any leaks are detected, close the valve and correct the problem before proceeding.

IMPORTANT NOTE

If a leak occurs at a “Push In” plastic fitting, then refer to Fig. 6.

- 3) Open the storage tank valve and lift the faucet handle until a steady stream of water flows. Close the faucet, wait at least 5 minutes and carefully check for leaks. Correct them as necessary.

IMPORTANT NOTE

When the appliance is first turned on, water may intermittently “spurt” from the air gap opening at the side of the faucet. This is perfectly normal, and is caused by air trapped in the system. This will usually disappear within a short time.

‘Push-In’ Tubing Connector

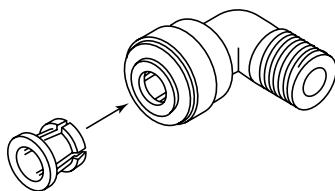

This product is outfitted with user friendly ‘Push In’ connectors. Proper use of the connectors is shown in Figure 3.

It is most important that the tubing selected for use with these connectors be of high quality, exact size and roundness, and with no surface nicks or scratches. If it is necessary to cut the tubing, use a plastic tubing cutter or sharp razor knife. Make a clean square cut.

Should a leak occur at a ‘Push-In’ connector, the cause is usually defective tubing.

- To Fix:
- **Relieve pressure**
 - **Release tubing**
 - **Cut off at least 1/4” from end.**
 - **Reattach tubing**
 - **Confirm connection is leak free.**

Fig. 6

M. FLUSH THE APPLIANCE OF THE PRESERVATIVE AND CHECK THE OPERATION

- 1) With the tank valve closed (the tank should still contain the sanitizing solution at this point), open the faucet (set the faucet handle in the "up" position) and feed water valve. Water should begin to drip from the faucet within several minutes. Continue to flush the system for 24 hours. Water will steadily drip from the faucet at this time. During this procedure, the tank is being intentionally bypassed in order to thoroughly sanitize the tank and also flush the membrane of any preservatives.



WARNING

To reduce the risk associated with irritation from Sodium Metabisulfite during installation:

- Sodium Metabisulfite (CAS 07681-57-4) is used in a 1% preservative solution within the reverse osmosis membrane.
- Do not put this system into service before the RO tank is flushed as specified in the installation instructions. Wear eye and face protection during installation.
- To request an MSDS relating to this product, call 203-238-8965 or visit the web at http://solutions.3m.com/wps/portal/3M/en_US/MSDS (click MSDS search). For emergencies, call 800-364-3577 or 651-737-6501 (24 hours).

- 2) After flushing for 24 hours, shut off the faucet. Open the tank valve, lift the faucet handle again and allow the tank to completely empty. When the tank is empty, the faucet will drip steadily. Measure and record the rate at which water drips from the faucet. Use a graduated cylinder (in milliliters) and a watch with a second hand to calculate the approximate production in gallons per day (milliliters per minute x 0.38 = gpd). Proceed to check the reject flow by disconnecting the tubing at the drain connection and measuring the drip rate as outlined above. The ratio should be a minimum of 2.5 (reject) to 1 (product). Repeat every 5 minutes until the rate is constant. When the rate is constant, the tank is empty.
- 3) Allow the system to operate in this condition for 24 hours.
- 4) Close the faucet and reinspect the appliance for leaks. Allow the tank to fill completely (it will take approximately 4 hours), then drain the tank again. **The water should be discarded** because it may contain some sanitizing solution.
- 5) The appliance should be ready to use as soon as the tank refills. If any objectionable taste is noticed after the second tankful is drained, instruct the customer to wait and drain the tank the following day. Only at this time should an icemaker be turned on if one is connected to the appliance.

N. CLEAN UP AND PAPERWORK

- 1) Clean up the work area thoroughly.
- 2) Fill out the warranty card and return it.

For replacement parts and filters, please contact your dealer or call Water Factory Systems at 1-800-733-1199 or visit our website at www.waterfactorysystems.com.

This system has been tested for the treatment of water containing pentavalent arsenic (also known as As(V), As(+5), or arsenate) at concentrations of 0.30 mg/L or less. This system treats pentavalent arsenic, but may not affect other forms of arsenic. This system is to be used on water supplies containing a detectable free chlorine residual or on water supplies that have been demonstrated to contain only pentavalent arsenic. Treatment with chloramine (combined chlorine) is not sufficient to ensure complete conversion of trivalent arsenic to pentavalent arsenic. Please see the Arsenic Facts section of the Performance Data Sheet for further information.

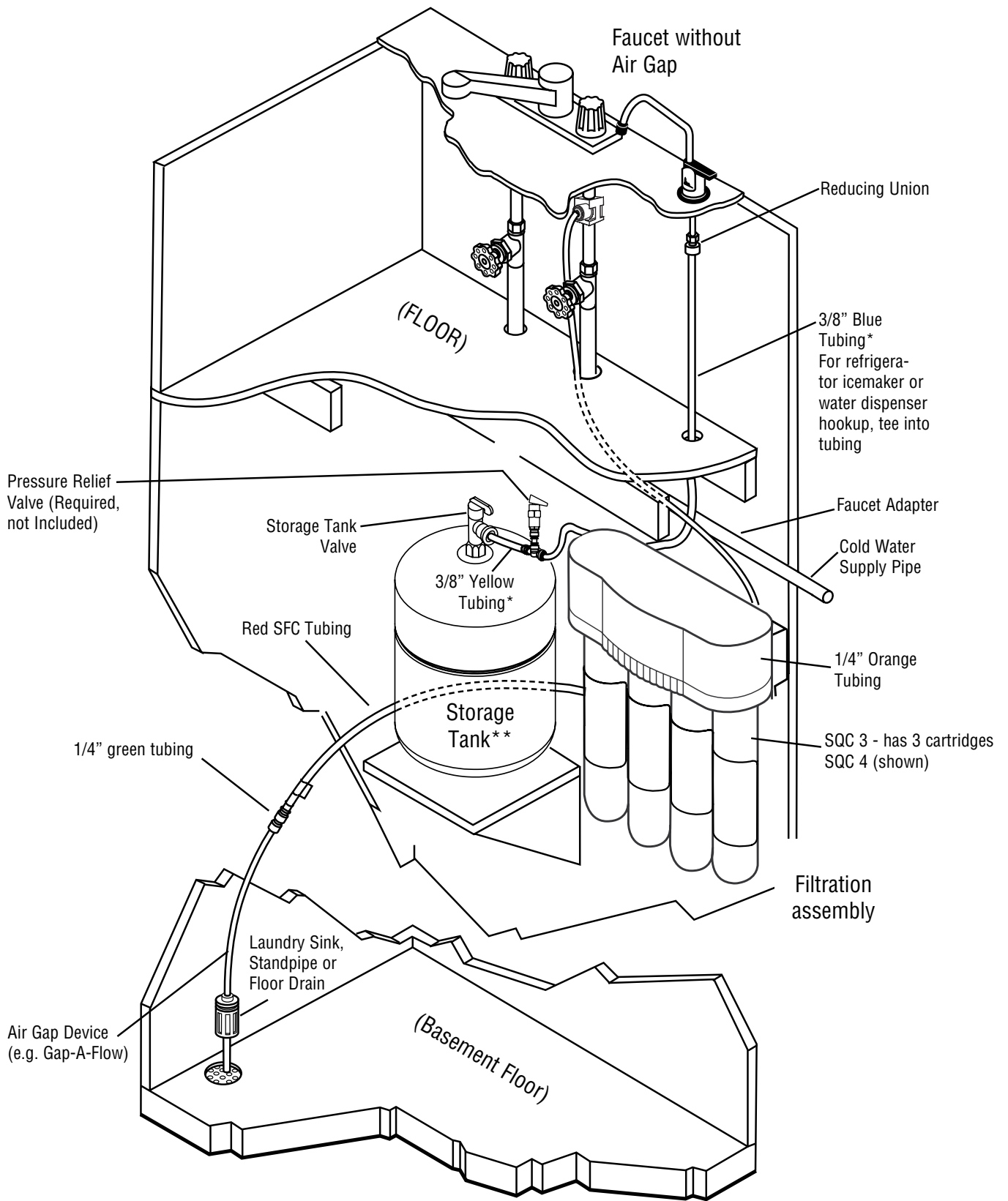

* For best flow, keep the tubing as short as possible

** Mount the storage tank on a shelf or strap it between two floor joists

Fig. 7

O. APPENDIX FOR BASEMENT INSTALLATIONS

The following variations are generally required for basement installations:

INSTALL THE DRAIN CONNECTION

For basement installations, the drain saddle is generally not used. Instead, the RO reject line (SFC tubing) is routed so that it drains into a laundry sink, floor drain, or standpipe through an approved air gap.

MOUNT THE FAUCET

If you choose to use the air gap faucet included with the RO system, follow the faucet installation instructions given earlier in this manual. Do not hook up any air gap tubing to the faucet since an alternate air gap will be used elsewhere in the drain line.

If you choose to use the optional non-air gap faucet, follow the instructions below.

- A) Familiarize yourself with all of the components shown in the diagram of the non-air gap faucet. (See Fig. 2)
- B) Install only the chrome base plate and rubber sealing washer onto the threaded nipple. (Plumbers' putty may be used in place of the sealing washer for a neater appearance.)
- C) Feed the threaded nipple through the sink/countertop mounting hole (a 9/16" hole is adequate).
- D) From underneath the sink/countertop, install the plastic bottom washer, flat washer, star washer, and hex nut onto the threaded nipple. Hand tighten the hex nut until the faucet feels snug.
- E) After rechecking the faucet orientation, tighten the hex nut with a 9/16" wrench until the faucet feels secure.
- F) From above the sink, make any minor orientation corrections by turning the faucet on its "flats" with a padded adjustable wrench. Use care so as not to mar the chrome finish.

INSTALL THE FILTRATION ASSEMBLY AND THE STORAGE TANK

The filtration assembly is generally mounted to the basement wall (using wall anchors) or to the wood ceiling supports. To mount the filtration assembly, keep the bracket level and mark the location of the mounting holes. Install wall anchors and/or mounting screws as required. Leave the screw heads protruding to allow the bracket mounting slots to slide over them. (See Fig. 7)

The tank may be oriented either vertically or horizontally and can be placed on a shelf, on the floor, or suspended from the ceiling supports using brackets.

An effort should be made to minimize the distance between the tank and filtration assembly in order to ensure an adequate flow rate to the faucet.

MAKE THE TUBING CONNECTIONS

- 1) A proper length of the 1/4" orange feed water tubing should already have been connected to the cold water supply shut off valve. Route it through the large opening in the bottom of the metal bracket and loop it back to the "FEED" connection on the filtration assembly.
- 2) Connect a longer length of 3/8" blue tubing (not included) to the faucet adapter. Route the tubing through the floor to the location of the filtration assembly. Remove the existing 3/8" blue tubing from the filtration assembly. Route the other end of the longer length of 3/8" blue tubing through the large opening in the bottom of the metal bracket and connect it to the "FAUCET" connection on the filtration assembly.

NOTE: Instead of removing the existing 3/8" blue tubing from the filtration assembly, a 3/8" connector fitting can be used to join the tubing from the faucet with the tubing from the filtration assembly.

- 3) Route the 3/8" yellow tubing from the filtration assembly to the storage tank.
- 4) Route 1/4" tubing from an appropriate drain connection (e.g. laundry sink, floor drain, standpipe) to the location of the filtration assembly. An air gap must be provided between the outlet and the drain connection.
- 5) Connect the red SFC tubing from the filtration assembly to the 1/4" tubing from the drain connection using the 1/4" connector fitting on the end of the SFC tubing.

P. INSTALLATION TROUBLESHOOTING

Problem: Leak at the drain saddle.

Possible Cause: Drain saddle not clamped tightly enough.

Solution: Tighten the drain saddle screws evenly and firmly.

Problem: Leak at the fittings threaded connection.

Possible Cause: Fitting is improperly taped or not tightened sufficiently.

Solution: Retape the threaded portion with PTFE tape and thread it in firmly. Do not over tighten.

Problem: Leak at the fitting's push-in connection.

Possible Cause: Tubing is damaged if there is a tubing mis-assembly.

Solution: Remove the tubing. Squarely cut off 1/4 inch from the end of the tubing using a sharp razor knife and reinsert it into the fitting. Make sure that the tubing is pushed in completely until it seats.

Problem: Leak at the filter cartridge head.

Possible Cause: Damaged or misaligned O-ring.

Solution: Close the cold water supply shut off valve and the storage tank valve. Lift up on the faucet handle and drain the tank a minimum of 5 minutes. Remove the filter cartridge and check the condition of the O-rings. If they are misaligned, reseal them. If they are damaged, replace them.

Problem: The faucet leaks from the spout with the handle down.

Possible Cause: An obstructed or damaged valve seat in the faucet mechanism.

Solution: Remove the faucet spout with a twisting/lifting motion and slide the faucet handle forward over the spout hole to gain access to the faucet valve. Unscrew the tee-bar and the slotted bushing to remove the valve. Clean out any obstruction or replace it with a new valve mechanism if necessary.

Problem: No steady drip from the open faucet after the tank is drained.

Possible Causes:

- The cold water supply shut off valve is not open.
- A leak from any product water fitting connection.
- The icemaker valve was left open before the start-up procedure completed.
- Air is still trapped in the system.

Solutions:

- Open the cold water supply shut off valve completely.
- Correct the fitting leak as outlined above.
- Close the icemaker valve and wait until the faucet drips.
- Wait for the air to be purged from the system.

Problem: Water leaks from air gap module opening.

Possible Causes:

- The drain line tubing is looped, kinked, or has a low spot.
- The drain line is blocked or the drain hole is not drilled through completely.
- Air is locked in the air gap outlet.
- There is excessive RO reject flow.

Solutions:

- Trim any excess tubing to obtain a short, "straight-shot" to the drain.
- Check to see that the drain line is clear of any obstruction and remove the drain saddle fitting to verify that the hole is drilled through completely.
- Blow air into the air gap outlet using a short length of tubing.
- Disconnect the red SFC reject tubing from the faucet air gap inlet tubing and check the reject flow rate. It should be less than 5.9 ounces/min. If it is greater than 5.9 ounces/min, replace the red SFC reject tubing with the new one of proper length.

Problem: Too little or no reject flow.

Possible Causes:

- Red SFC reject tubing is plugged or damaged.
- An obstruction in the faucet air gap module.

Solutions:

- Replace the SFC reject tubing with one of proper length.
- Remove the air gap module and inspect the internal flow path. Replace the air gap module if necessary.

Problem: Chlorine or other unpleasant taste/odor is evident after the initial tank filling.

Possible Cause: Residual preservative/sanitizer is still in the water.

Solution: Drain and fill the storage tank several times if necessary.

Problem: Noise in the drain (gurgling or dribbling sound).

Possible Cause: The reject water is dripping into the standing water in the drain trap.

Solutions:

- Make sure that the 3/8" black drain tubing from the faucet air gap module slopes continuously downward to the drain saddle without any loops or low spots.
- Angle the drain piping so that the reject water runs down the side of the drain pipe.
- Change the location of the drain saddle to the horizontal drain pipe or any alternate vertical drain pipe which is farther from the trap. Properly plug the original hole.
- Drill larger hole in drain pipe.

Caution: Make sure the drain saddle is always installed above (before) the trap.

II. Operation & Maintenance Instructions

CAUTION

To reduce the risk associated with property damage due to water leakage:

- **Read and follow** Use Instructions before installation and use of this system.
- Installation and use **MUST** comply with all state and local plumbing codes.
- **Protect from freezing**, remove filter cartridge when temperatures are expected to drop below 40° F (4.4° C).
- **Do not install** if water pressure exceeds 100 psi (690 kPa). If your water pressure exceeds 80 psi (552 kPa), you must install a pressure limiting valve. Contact a plumbing professional if you are uncertain how to check your water pressure.
- **Do not install** where water hammer conditions may occur. If water hammer conditions exist you must install a water hammer arrester. Contact a plumbing professional if you are uncertain how to check for this condition.
- The disposable filter cartridge **MUST** be replaced every 12 months, at the rated capacity or sooner if a noticeable reduction in flow rate occurs.
- The RO Membrane cartridge **MUST** be replaced at least every 36 months.

A. IMPORTANT WATER QUALITY ASSURANCE REQUIREMENTS

Reverse Osmosis drinking water appliances contain treatment components that are critical for the effective reduction of Total Dissolved Solids (TDS) as well as inorganic chemical contaminants. Water Factory Systems™ strongly recommends that the user test the water periodically (every six to twelve months minimum) to verify that the appliance is performing satisfactorily. Your dealer may offer a water testing service. Routine maintenance is necessary in the form of prefilter, postfilter, and membrane replacement, based on the following guidelines:

- Sediment, Carbon, or Sediment/Carbon Prefilters, and Carbon Postfilters: Change every 12 months or sooner depending on the feed water quality.
- RO Membrane: Change it as required based on Percent Rejection. A testing service may be offered by your dealer every 36 months or sooner.

B. REPLACING THE FILTER CARTRIDGES

The life of the prefilter cartridge generally depends on the local water conditions (i.e., dirt, rust and/or chlorine levels) while the life of the postfilter cartridge(s) is generally determined by the length of service.

When to Replace the Sediment Replacement Filter

- Every twelve (12) months or sooner depending on local water conditions.
- A noticeable decrease in water production is an indication that the filter requires changing.

When to Replace the Granulated Carbon Replacement Filter

The granulated carbon replacement filter reduces free chlorine in the feed water supply to protect the TFCM membrane from chlorine attack. To find out the chlorine level in a water supply, call the public water supplier.

When to Replace the Carbon Block Replacement Post-Filter

- If the filter is being used to control tastes and odors, replace it every twelve (12) months or sooner depending on local water conditions.

When to Replace the Carbon Postfilter Cartridge

Change at a minimum of 12 months or sooner, depending on feed water quality.

How to Replace the Prefilter and Postfilter Cartridges

- 1) Lift up on the faucet handle to drain the tank. Close the cold water supply valve. Wait five (5) minutes for the filtration assembly to completely depressurize.
- 2) Remove cover and twist the filter cartridge 1/4 turn clockwise so that the ears on the cartridge are able to disengage from the head. Firmly pull the cartridge from the head. It may be necessary to twist the cartridge slightly from side to side to help free it. (See Fig. 8)
- 3) Remove the new filter cartridge from its sanitary sealed wrapper. (Double check to see that it is the correct replacement by comparing the labels.)
- 4) Using tap water, wet the o-ring seals to make cartridge insertion easier.
- 5) Line up the cartridge ears, insert the cartridge and push it into the head until it is fully seated. Twist the cartridge 1/4 turn counterclockwise to lock it into place.
- 6) Open the cold water supply valve and carefully check for leaks.
- 7) **RO System Flush Instructions:**
Prefilter: Flush at least 2 gallons of water through filter before use.
Postfilter: Flush at least 2 gallons of water through filter before use.
RO Membrane Cartridge: Run product water to drain for 24 hours.

C. REPLACING THE RO MEMBRANE CARTRIDGE

The life of the RO membrane cartridge depends on the local water conditions and proper maintenance, e.g., regular filter changes. The maximum recommended service life is 36 months. Unlike the filter cartridges, the RO membrane cartridge life is not determined by the amount of water used because of its self-cleaning feature.

How to Replace the RO Membrane Cartridge

- 1) Close the cold water supply shut off valve. Lift up on the faucet handle to drain the tank. Wait five (5) minutes for the filtration assembly to completely depressurize.
- 2) Make sure that there is some slack in the red SFC tubing connected to the fitting at the bottom of the RO membrane cartridge. Twist the cartridge 1/4 turn clockwise so that the tubing connection is accessible. (See Fig. 8)
- 3) Remove the red SFC tubing by depressing the small gray collet and pulling the tubing away from the fitting.

Note: It is advisable to check the end of the red SFC tubing for nicks or scratches. If any are observed, cut off 1/4" from the end of the tubing with a sharp razor knife.

- 4) Firmly pull the cartridge away from the head. (It may be necessary to twist the cartridge slightly from side to side.)
- 5) Remove the new RO membrane cartridge from its sanitary sealed wrapper. (Double check to see that it is the correct replacement by comparing the labels.) Rinse it with tap water and dry it off.
- 6) Remove the white plug from the fitting at the bottom of the cartridge by pushing in the small gray collet and pulling out the plug.
- 7) Remove the red plastic cap from the top of the cartridge.
- 8) Using tap water, food grade silicone lubricant or glycerin, wet the O-ring seals to make cartridge insertion easier.
- 9) Reconnect the red SFC reject tubing by inserting it into the fitting at the bottom of the new RO membrane cartridge as far as it will go. Line up the cartridge ears, insert the cartridge and push it into the head until it is fully seated. Twist the cartridge 1/4 turn counterclockwise to lock it into place.
- 10) Open cold water supply valve and carefully check for leaks. Carefully inspect the fitting at the bottom of the new RO membrane cartridge.
- 11) Follow the sanitizing procedure for the storage tank and the filtration assembly outlined below.

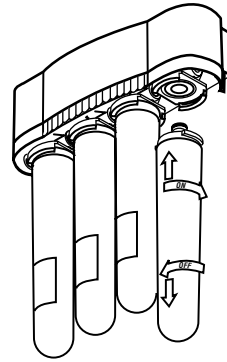

Remove the red SFC tubing from the fitting before completely removing the RO membrane module

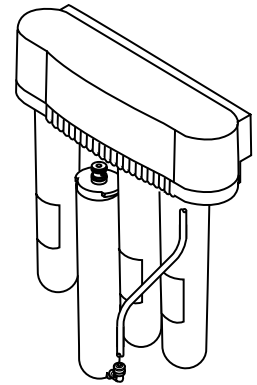

Fig. 8

D. YEARLY MAINTENANCE SANITIZATION* SANITIZING THE RO APPLIANCE

To assure the highest quality water from your RO Drinking Water Appliance, it is important to routinely sanitize both the storage tank and the filtration assembly.

IMPORTANT: These procedures are only intended to be part of a routine maintenance program only and are not designed to sanitize systems that have become highly contaminated from misuse.

When to Sanitize the Storage Tank

- Upon start-up as described in the beginning of this manual.
- After any servicing or routine maintenance that involves replacing the RO membrane cartridge, the postfilter(s), servicing the storage tank, or replacing the RO faucet.

When to Sanitize the Filtration Assembly

- After any servicing or routine maintenance that involves replacing the RO membrane cartridge, the postfilter(s), servicing the storage tank, or replacing the RO faucet.
- After any extended period of non-use (over 30 days) unless the cartridges are stored inside a sealed plastic bag in the refrigerator.

* Initial sanitization to be performed using instructions on page 6.

How to Sanitize the Storage Tank and Filtration System

Sanitizing the storage tank generally requires:

- Common household bleach (5.25% non-scented)
 - Eye dropper or plastic oral syringe
- 1) Close the cold water feed valve and lift up on the faucet handle to empty the water in the storage tank. It should feel light when empty.
 - 2) Disconnect the 3/8" yellow tubing (system tank) from the ball valve on top of the storage tank.
 - 3) Insert into the yellow tubing 1/2 teaspoon (3 ml) of household bleach. (See Fig 9)
 - 4) Reconnect the yellow tube to the tank ball valve.
 - 5) Close the RO faucet and open the cold water feed valve.
 - 6) Wait 4-5 hours.
 - 7) Lift up the handle of the RO faucet and allow contents of tank to drain completely into the sink.
 - 8) Sanitizing is now complete.
 - 9) If there is any residual chlorine/bleach taste in the next tank full, drain tank completely a second time.

E. LONG TERM NON-USE

If the RO appliance is to be left unused for a long period of time (greater than 30 days), follow this procedure:

- 1) Lift up on the faucet handle to drain the storage tank and close the cold water supply shut off valve. Wait five minutes for the filtration assembly to depressurize.
- 2) Remove all of the filter cartridges. Turn the cartridges upside down in the sink to drain out as much water from them as possible.
- 3) Place the cartridges in an air tight plastic bag and store them in the refrigerator.

IMPORTANT NOTE:

The cartridges must not be allowed to freeze because permanent damage may occur, which may result in property damage due to water leakage.

- 4) When the RO appliance is ready to be put back into service, reinstall the filter cartridges by matching the symbols on the top of the cartridge labels with the ones on the filtration assembly heads. Sanitize the storage tank as described in the previous section. The filtration assembly can be sanitized at this time if so desired.
- 5) Follow the start up procedure outlined in the previous section.

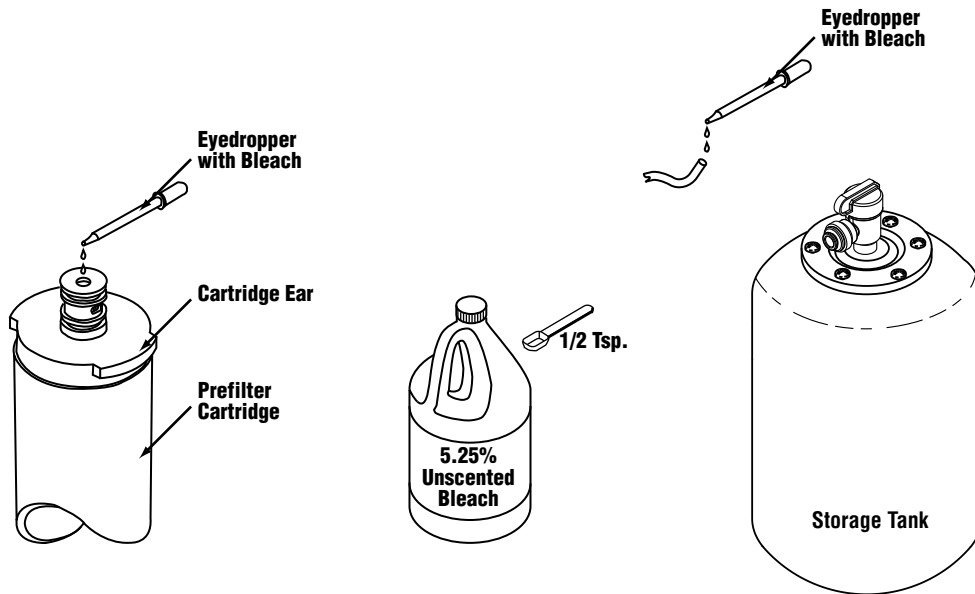



Fig. 9



WARNING

To reduce the risk associated with ingestion of water contaminated with sanitizer:

- Sanitizer must be flushed from the system before using as directed within the installation instructions.

To reduce the risk of injury associated with household bleach:

- **Read and follow** manufacturers directions and cautions
- **Keep out of the reach of children**
- **DO NOT** intermix with other chemicals

Limited Warranty: 3M Purification Inc. warrants this Product will be free from defects in material and manufacture for the following periods from the date of purchase: Ten (10) years for the Product, except for the replacement filter cartridge and membrane, which are warranted for one (1) year. This warranty does not cover failures resulting from abuse, misuse, alteration or damage not caused by 3M or failure to follow installation and use instructions. No warranty is given as to the service life of any filter cartridge or membrane as it will vary with local water conditions and water consumption. If the Product fails to satisfy this Limited Warranty during the warranty period, 3M will replace the Product or refund your Product purchase price. This warranty does not cover labor. The remedy stated in this paragraph is Customer's sole remedy and 3M's exclusive obligation.

This warranty gives you specific legal rights, and you may have other rights which may vary from state to state, or country to country. For any warranty questions, please call 1-866-990-9785 or mail your request to: Warranty Claims, 3M Purification Inc., 400 Research Parkway, Meriden, CT 06450. Proof of purchase (original sales receipt) must accompany the warranty claim, along with a complete description of the Product, model number and alleged defect.

Limitation of Liability: 3M will not be liable for any loss or damage arising from this 3M product, whether direct, indirect, special, incidental, or consequential, regardless of the legal theory asserted, including warranty, contract, negligence or strict liability. Some states and countries do not allow the exclusion of limitation of incidental or consequential damages, so the above limitation or exclusion may not apply to you.



3M Purification Inc.

400 Research Parkway
Meriden, CT 06450, U.S.A.

Tel (800) 733-1199

(203) 237-5541

Fax (203) 203-8701

www.3Mpurification.com

www.waterfactorysystems.com

Please recycle. Printed in U.S.A.

Water Factory System is a trademark of 3M Company used under license.

3M is a trademark of 3M Company.

© 2010 3M Company. All rights reserved.

98-880040 0210